

Technische informatie

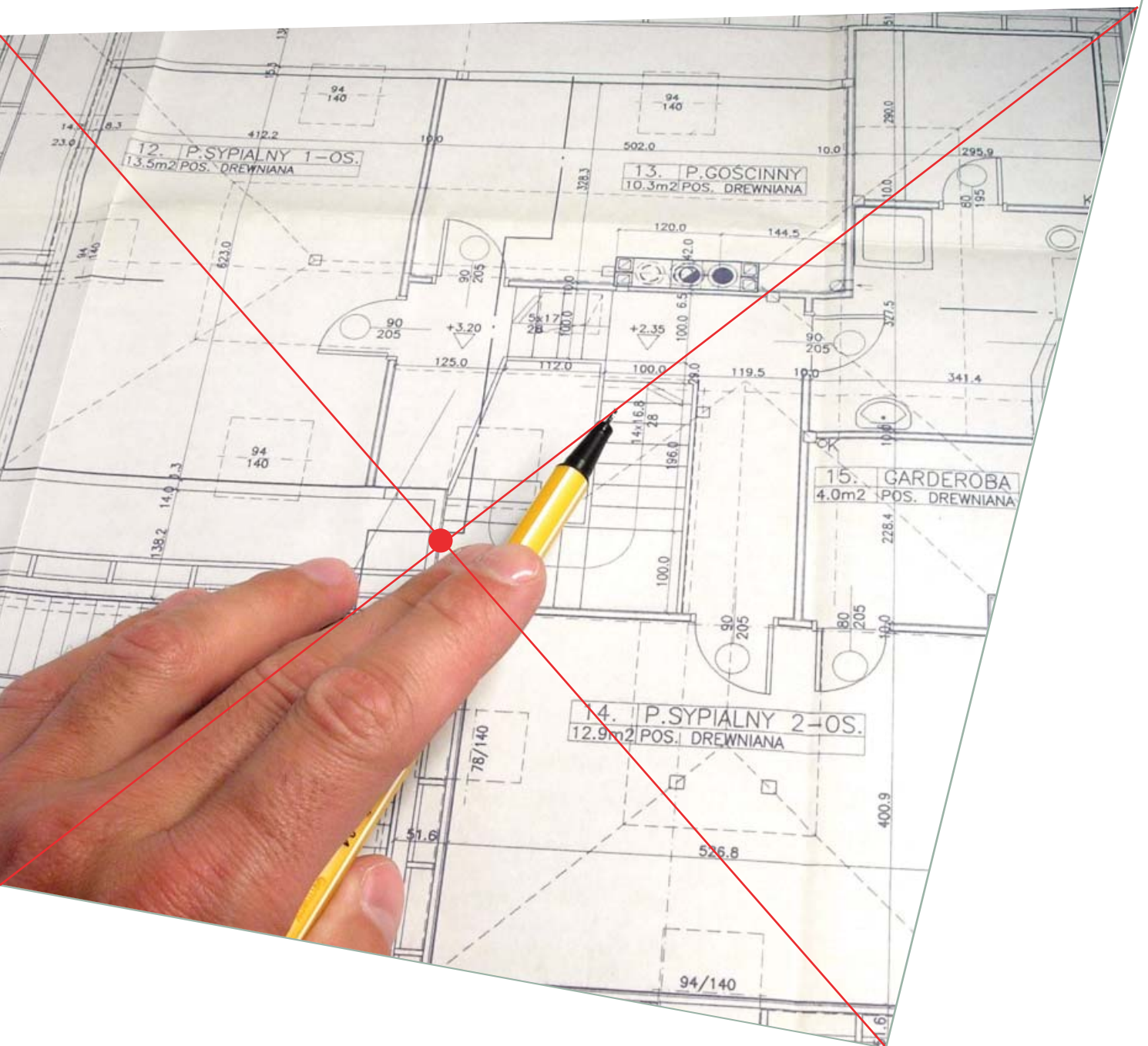

Hang- en sluitwerk

draaipunten, in relatie tot deurgewicht

Standaard
(honingraat)

opdek
stomp

deurbreedte in mm:	tot en met 930mm			930>x<1030		
deurhoogte in mm.	2115	2315	>2315 wordt extra	2115	2315	>2315 wordt extra
Z-paumelle	2	3		2	3	
Plus-paumelle	2	3		2	3	
Fluence blad paumelle	2	3		2	3	
penfits 76x76	2	3		2	3	
kogellagerscharnier 89x89	3	3		3	3	
kogelpaumelle 89x89	3	3		3	3	

Extra
(tubespaan)

opdek
stomp

deurbreedte in mm:	tot en met 930mm			930>x<1230		
deurhoogte in mm.	2115	2315	2600	2115	2315	2600
Z-paumelle	2	3	3	3		
Plus-paumelle	2	3	3	3	3	
Fluence blad paumelle	2	3	3	3	3	
penfits 76x76	3					
kogellagerscharnier 89x89	3	3	3	3	3	3
kogelpaumelle 89x89	3	3	3	3	3	3

30min
(volspaan)

opdek
stomp

deurbreedte in mm:	tot en met 930mm			930>x<1230		
deurhoogte in mm.	2115	2315	2600	2115	2315	2600
Z-paumelle						
Plus-paumelle	3	3				
Fluence blad paumelle	3	3				
kogellagerscharnier 89x89	3	3	3	3	3	
kogelpaumelle 89x89	3	3	3	3	3	3

60min
(met 50mm deur)

stomp

deurbreedte in mm:	tot en met 930mm			930>x<1030		
deurhoogte in mm.	2115	2315	2508	2115	2315	2508
kogellagerscharnier 89x89	3	4	4			
kogelpaumelle 89x89	3	4	4	4	4	4
projectscharnier 102x93	3	4	4	4	4	4

60min
(met 40mm deur)

stomp

deurbreedte in mm:	tot en met 930mm			930>x<1093		
deurhoogte in mm.	2115	2315	2703	2115	2315	2703
kogellagerscharnier 89x89	3	3	3	3	3	3
kogelpaumelle 89x89	3	3	3	3	3	3

indicatie deurgewicht

standaard (honingraatdeur)	ca. 8 kg/m ²
extra (tubespaan deur)	ca. 15 kg/m ²
extra plus (volspaan deur)	ca. 21 kg/m ²
30 min (brandwerende deur)	ca. 21 kg/m ²
60 min (brandw. deur, 50mm)	ca. 26 kg/m ²
60 min (brandw. deur, 40mm)	ca. 19 kg/m ²

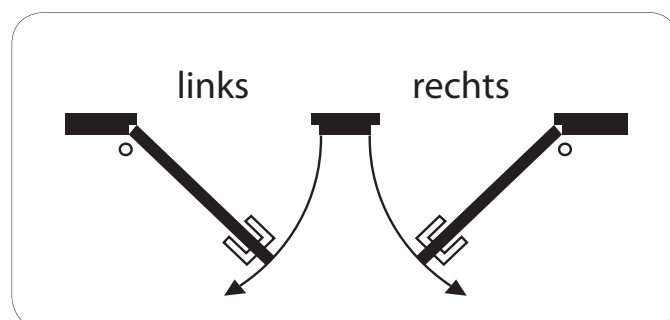

draairichting bovenaanzicht

Scharnieren & paumelles

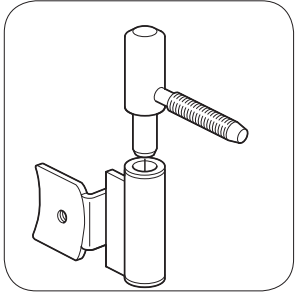

Z-paumelle voor Solid® inmetSELkozijnen, in opdek-uitvoering, verzinkt

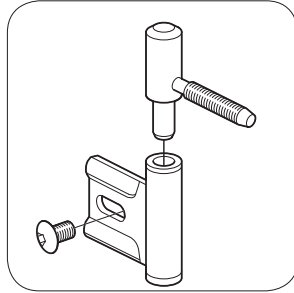

Plus paumelle voor MonoPlus® montagekozijnen, in opdek-uitvoering, verzinkt

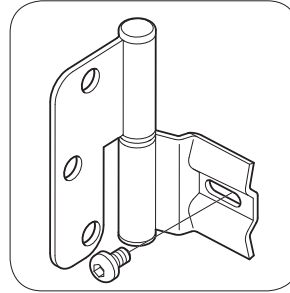

Fluence® blad paumelle voor stompe uitvoering (1mm) vernikkeld, Optioneel in rvs.

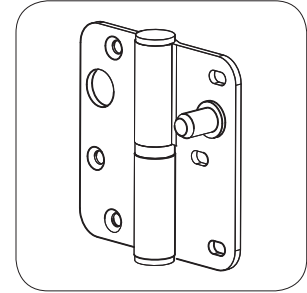

veiligheidsscharnier met nok, verzinkt SKG**

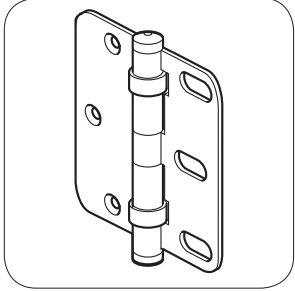

kogellagerscharnier 89x89 mm rvs of verzinkt

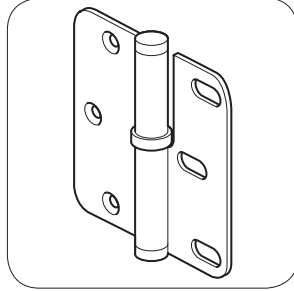

kogelpaumelle 89x89 mm rvs of verzinkt

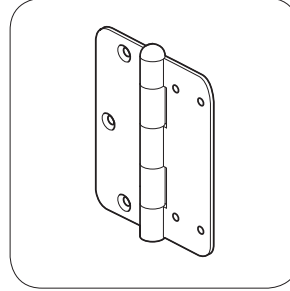

penfits 76x76 mm verzinkt

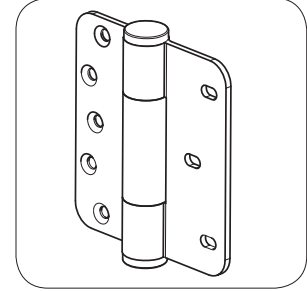

projectsscharnier 102x93 rvs

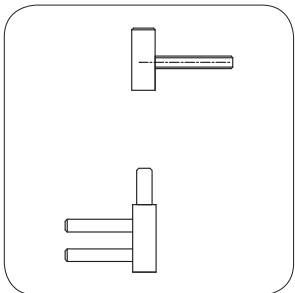

V3420 scharnier Fiber kozijn opdek

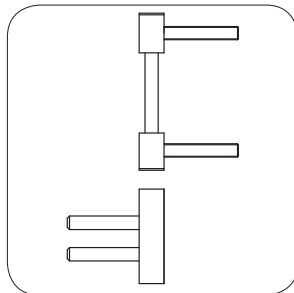

V4426 scharnier Fiber kozijn opdek

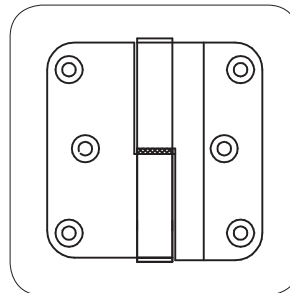

Argenta 80x80 scharnier Fiber kozijn stomp aluminium of RVS

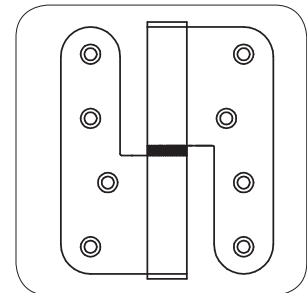

Argenta 100x86 scharnier Fiber kozijn stomp

Speciale voorzieningen

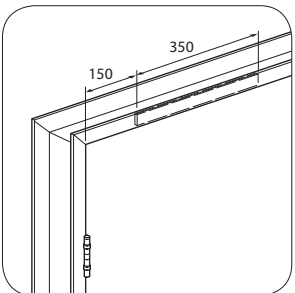

deurdranger voorziening voor brandwerende kozijnen zonder bovenlicht

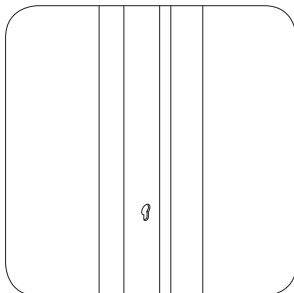

dictator voorziening voor brandwerende kozijnen met bovenlicht

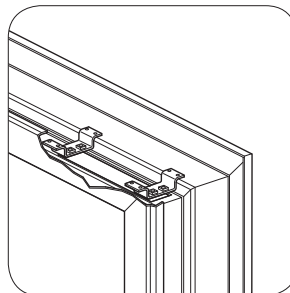

speunvoorziening t.b.v. doordraaideuren

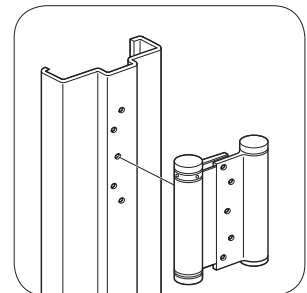

bommer scharnier t.b.v. doordraaideuren



dictator deurveer opdek bovenzijde deur

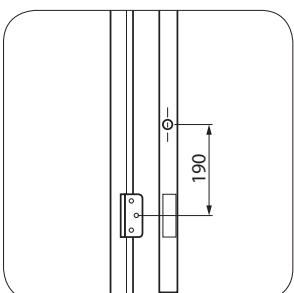

dictator deurveer stomp onderzijde deur

paumelle-inkrozingen bij standaard deurhoogtes in stalen MonoPlus & Solid kozijnen

z-paumelle en MonoPlus-paumelle

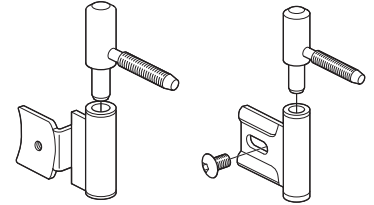

z-paumelle

MonoPlus-paumelle

2015

2 paumellen

3 paumellen

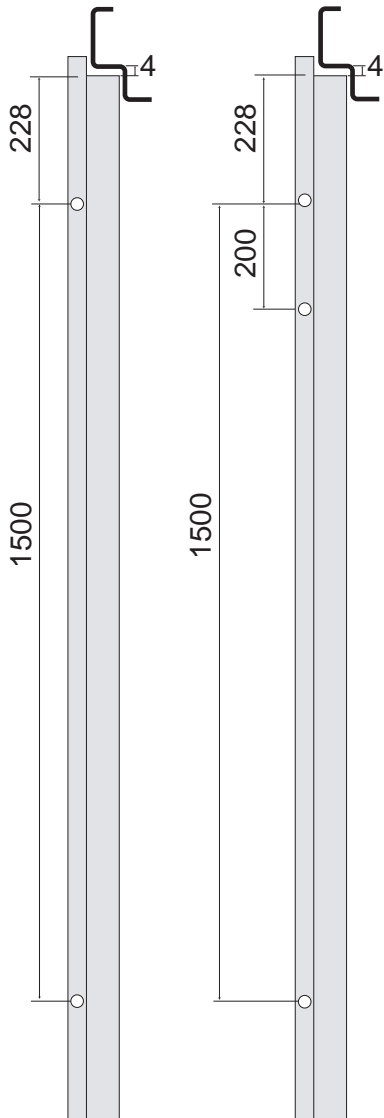

2115

2 paumellen

3 paumellen

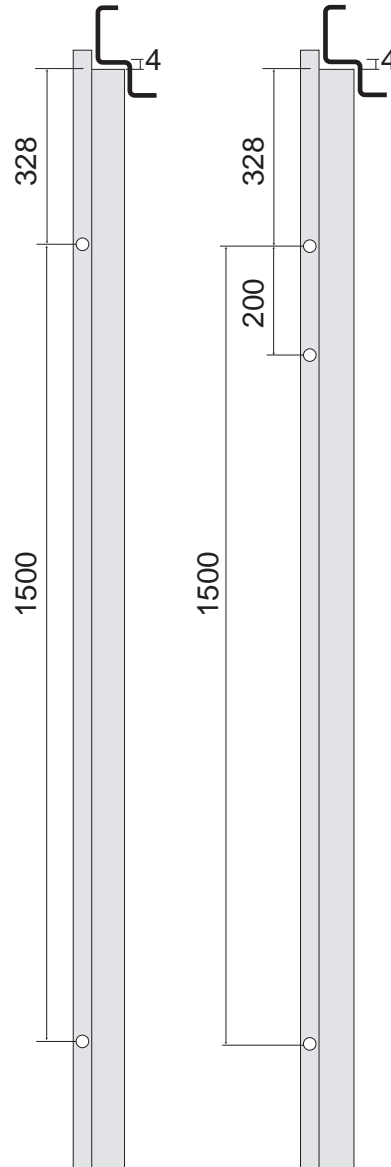

2315

3 paumellen

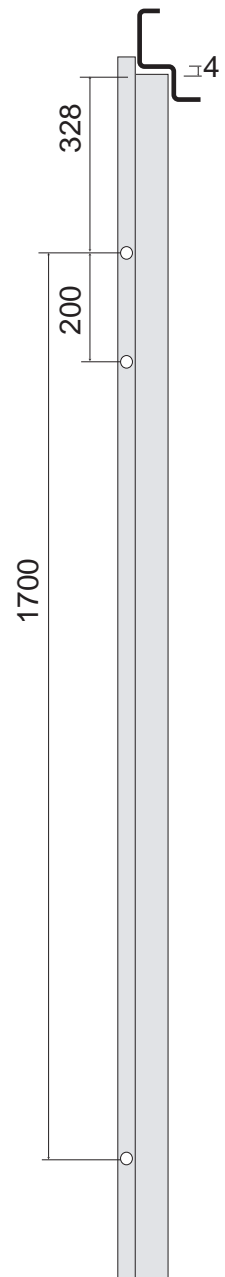

paumelle-inkrozingen bij afwijkende deurhoogtes in stalen MonoPlus & Solid kozijnen

z-paumelle en MonoPlus-paumelle

maatvoering paumelle-inkrozingen

2 paumellen

deurhoogte	paumelle 1 1	paumelle 2 1-2
1791 t/m 1890	228	1300
1891 t/m 1990	228	1400
1991 t/m 2090	228	1500
2091 t/m 2190	328	1500

maatvoering paumelle-inkrozingen

3 paumellen

deurhoogte	paumelle 1 1	paumelle 3 1-3	paumelle 2 1-2
1791 t/m 1890	228	200	1300
1891 t/m 1990	228	200	1400
1991 t/m 2090	228	200	1500
2091 t/m 2190	328	200	1500
2191 t/m 2294	328	200	1600
2295 t/m 2360	328	200	1700
2361 t/m 2390	328	246	1746
2391 t/m 2410	328	276	1776
2411 t/m 2440	328	296	1796
2441 t/m 2480	328	326	1826
2481 t/m 2520	328	366	1866
2521 t/m 2550	328	406	1906
2551 t/m 2580	328	436	1936
2581 t/m 2680	328	466	1986

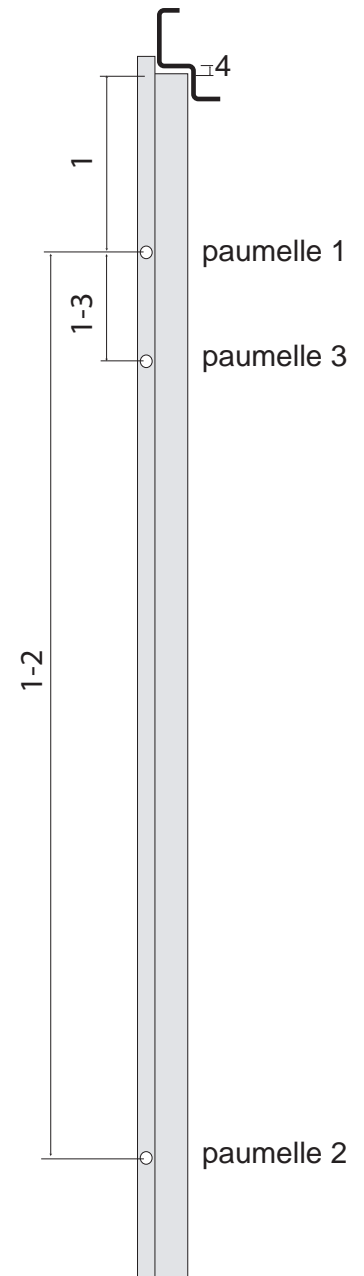

scharnier-inkrozingen bij standaard deurhoogtes in stalen MonoPlus & Solid kozijnen

penfits, kogellagerscharnier, kogelpaumelle, projectscharnier & fluence

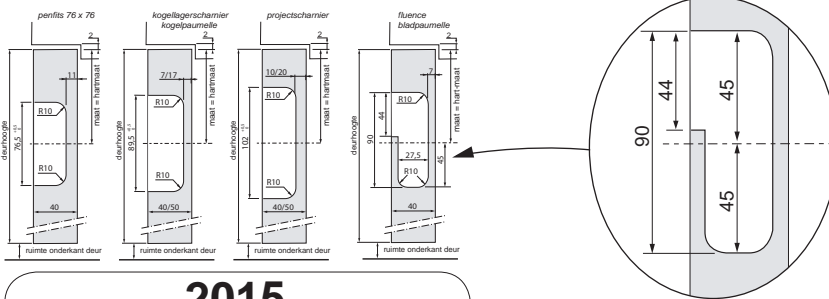

2015

2 scharnieren
(alleen bij penfits)

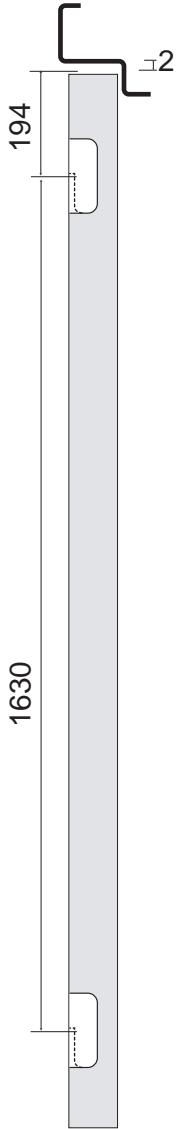

3 scharnieren
3e niet in het midden

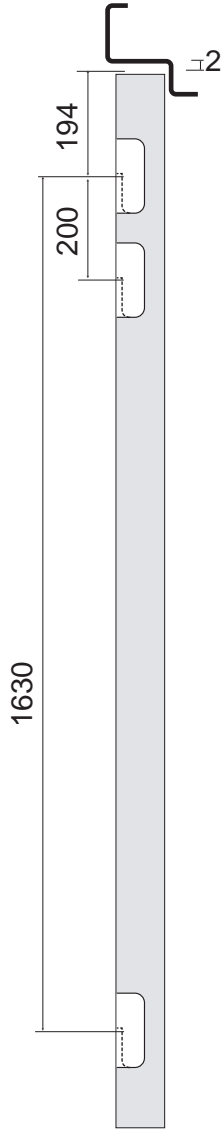

3 scharnieren
3e in het midden

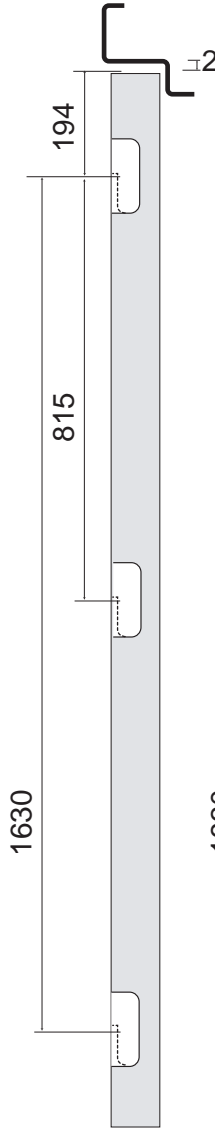

4 scharnieren

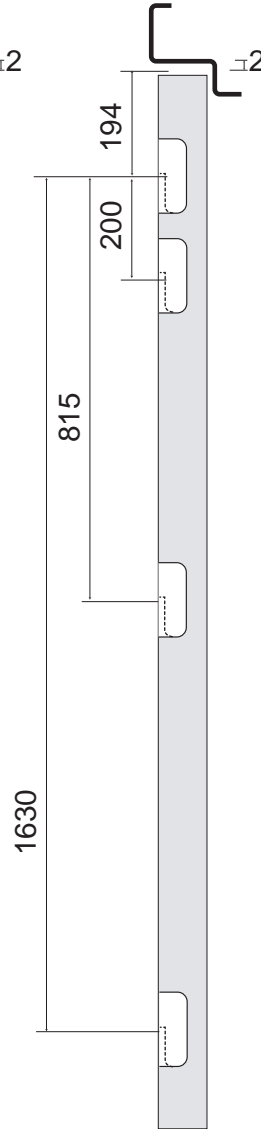

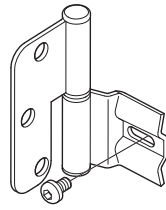

fluence bladpaumelle

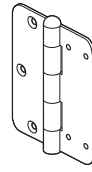

penfits
76x76

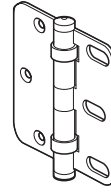

kogellagerscharnier
89x89

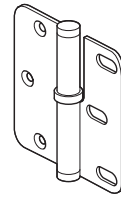

kogelpaumelle
89x89

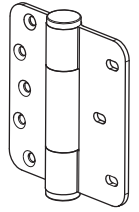

projectscharnier
102x93

2115

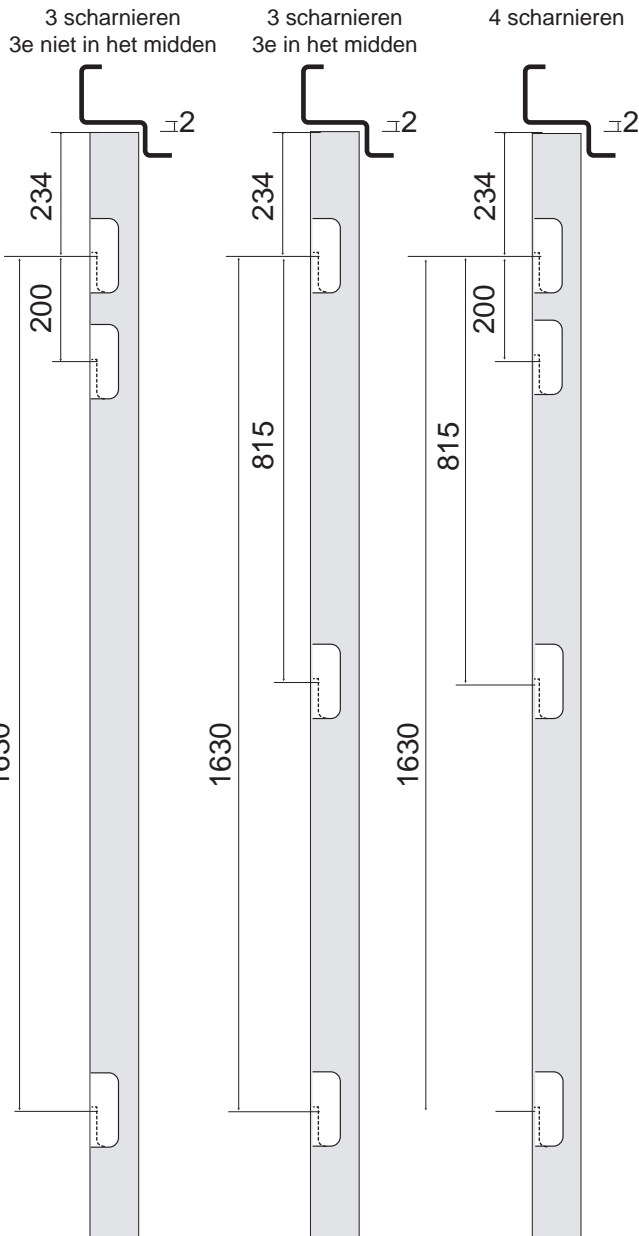

2315

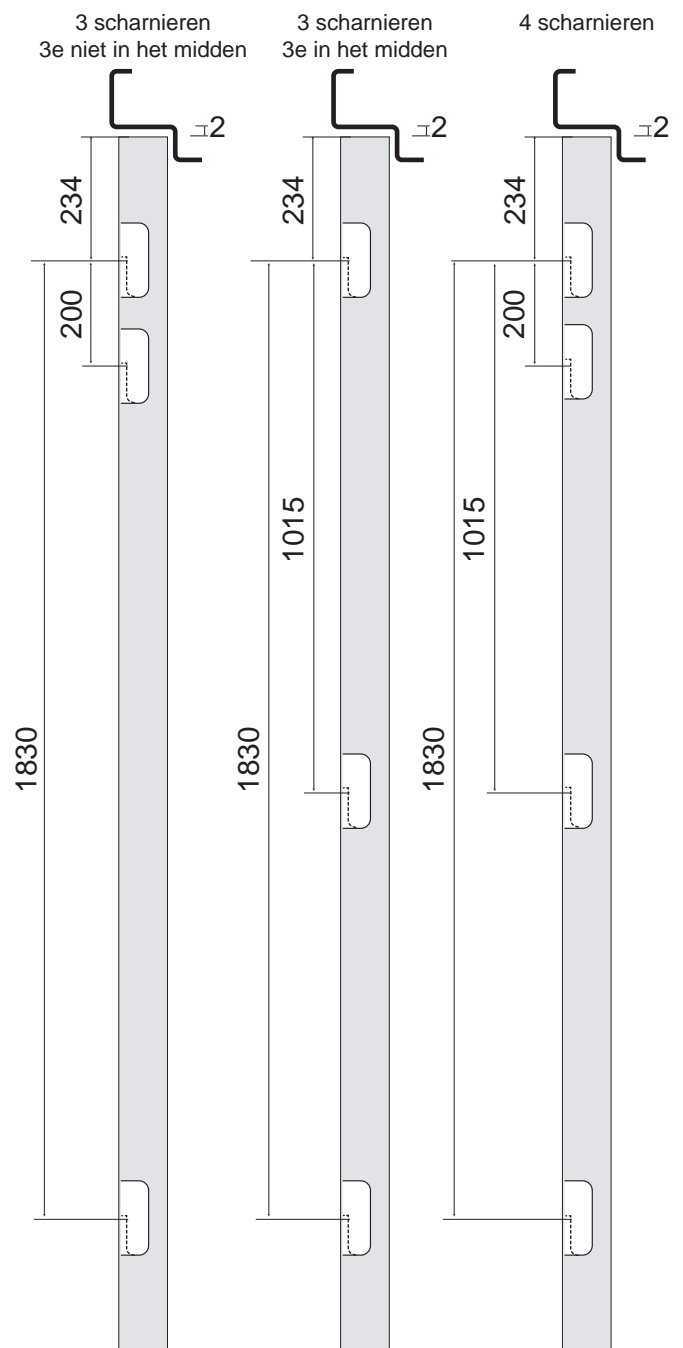

scharnier-inkrozingen bij afwijkende deurhoogtes in stalen MonoPlus & Solid kozijnen

penfits, kogellagerscharnier, kogelpaumelle, projectscharnier & fluence

maatvoering scharnier-inkrozingen

2 scharnieren

deurhoogte	scharnier 1 1	scharnier 2 1-2
1791 t/m 1890	194	1430
1891 t/m 1990	194	1530
1991 t/m 2090	194	1630
2091 t/m 2190	234	1630

maatvoering scharnier-inkrozingen

3 scharnieren 3e in het midden

deurhoogte	scharnier 1 1	scharnier 3 1-3	scharnier 2 1-2
1791 t/m 1890	194	715	1430
1891 t/m 1990	194	765	1530
1991 t/m 2090	194	815	1630
2091 t/m 2190	234	815	1630
2191 t/m 2294	234	915	1730
2295 t/m 2360	234	1015	1830
2361 t/m 2390	234	1061	1876
2391 t/m 2410	234	1091	1906
2411 t/m 2440	234	1111	1926
2441 t/m 2480	234	1141	1956
2481 t/m 2520	234	1181	1996
2521 t/m 2550	234	1221	2036
2551 t/m 2580	234	1251	2066
2581 t/m 2680	234	1281	2096

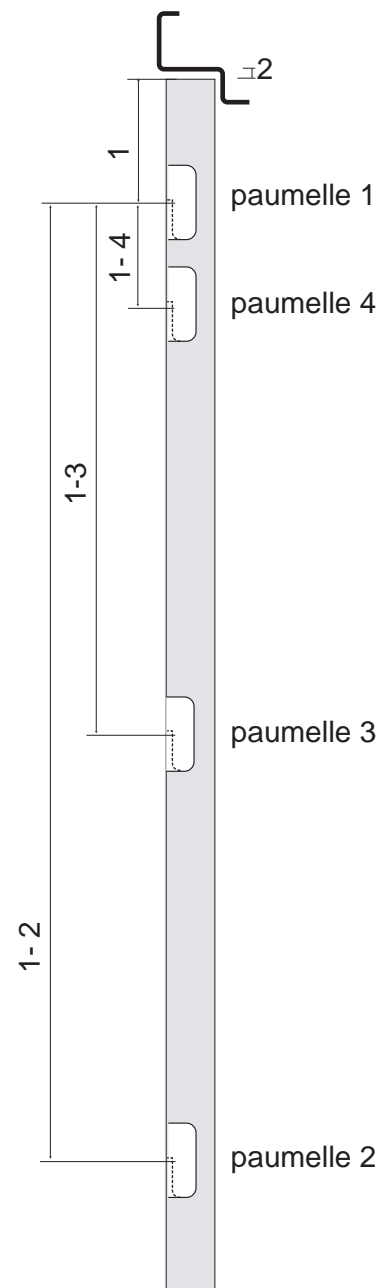

maatvoering scharnier-inkrozingen

3 scharnieren 3e niet in het midden

deurhoogte	scharnier 1	scharnier 3	scharnier 2
1791 t/m 1890	194	200	1430
1891 t/m 1990	194	200	1530
1991 t/m 2090	194	200	1630
2091 t/m 2190	234	200	1630
2191 t/m 2294	234	200	1730
2295 t/m 2360	234	200	1830
2361 t/m 2390	234	200	1876
2391 t/m 2410	234	200	1906
2411 t/m 2440	234	200	1926
2441 t/m 2480	234	326	1956
2481 t/m 2520	234	366	1996
2521 t/m 2550	234	406	2036
2551 t/m 2580	234	436	2066
2581 t/m 2680	234	466	2096

maatvoering scharnier-inkrozingen

4 scharnieren

deurhoogte	scharnier 1	scharnier 3	scharnier 2	scharnier 4
1791 t/m 1890	194	715	1430	200
1891 t/m 1990	194	765	1530	200
1991 t/m 2090	194	815	1630	200
2091 t/m 2190	234	815	1630	200
2191 t/m 2294	234	915	1730	200
2295 t/m 2360	234	1015	1830	200
2361 t/m 2390	234	1061	1876	200
2391 t/m 2410	234	1091	1906	200
2411 t/m 2440	234	1111	1926	200
2441 t/m 2480	234	1141	1956	326
2481 t/m 2520	234	1181	1996	366
2521 t/m 2550	234	1221	2036	406
2551 t/m 2580	234	1251	2066	436
2581 t/m 2680	234	1281	2096	466

paumelle-inkrozingen bij standaard deurhoogtes in Fiber houten montagekozijnen

V0020 paumelle en V0026 paumelle

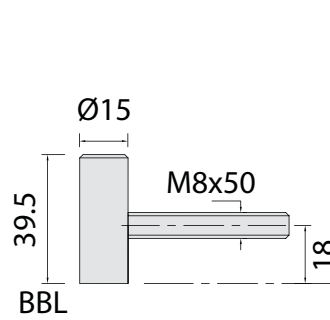

V0020 paumelle

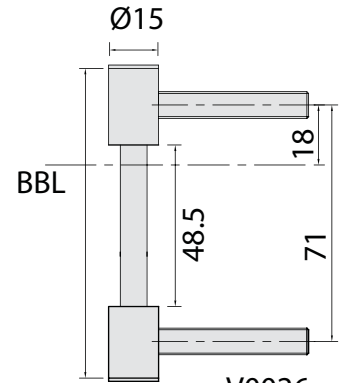

V0026 paumelle

2015

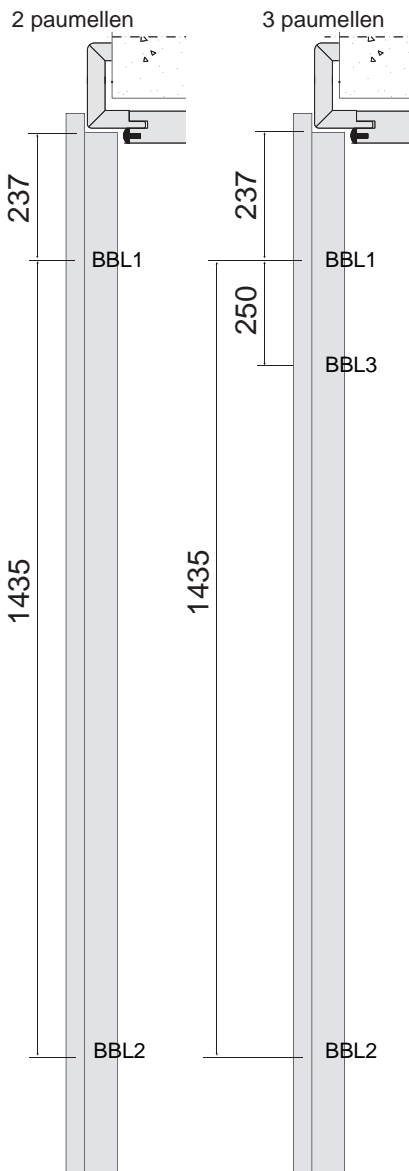

2115

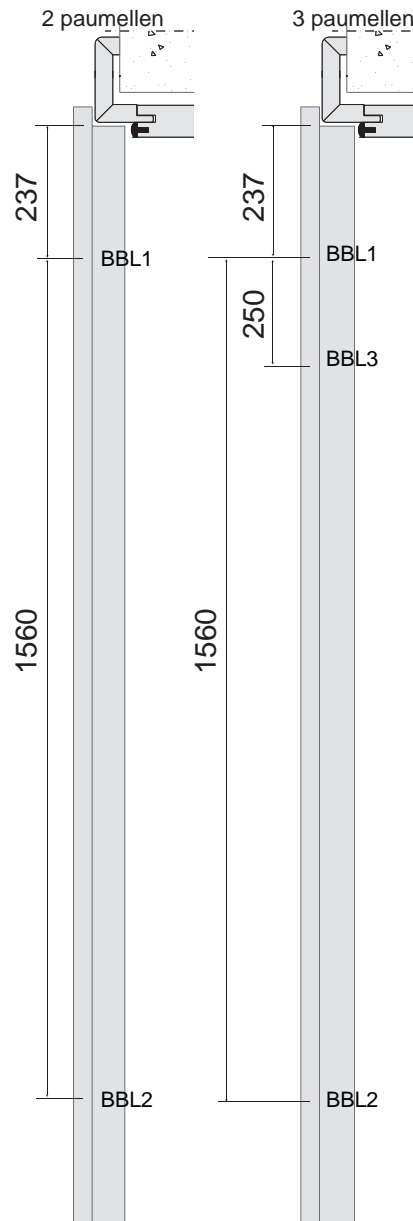

2315

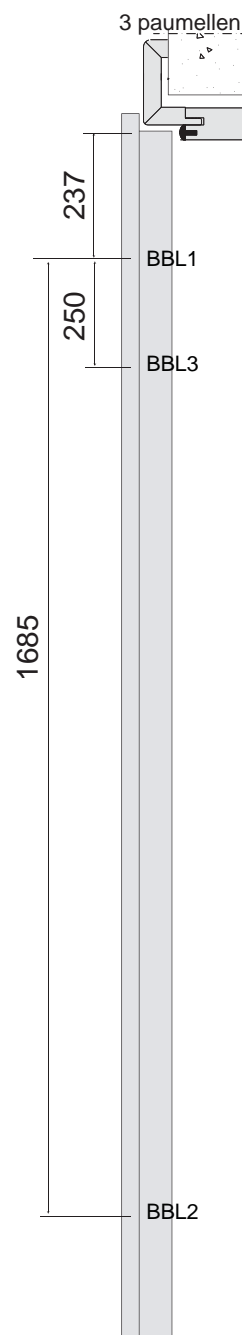

paumelle-inkrozingen bij standaard deurhoogtes in Fiber houten montagekozijnen

V0020 paumelle en V0026 paumelle

maatvoering paumelle-inkrozingen

2 paumellen

deurhoogte	BBL 1	BBL1 - BBL2
1800 t/m 1859	237	1310
1860 t/m 2110	237	1435
2111 t/m 2235	237	1560

maatvoering paumelle-inkrozingen

3 paumellen

deurhoogte	BBL1	BBL1-BBL2	BBL1-BBL3
1800 t/m 1859	237	1310	250
1860 t/m 2110	237	1435	250
2111 t/m 2235	237	1560	250

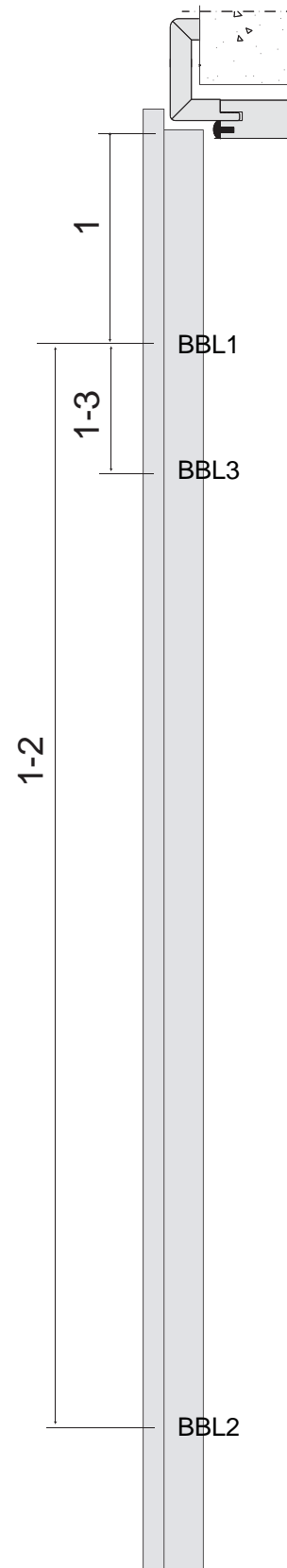

scharnier-inkrozingen bij standaard deurhoogtes in Fiber houten montagekozijnen Argenta 100x86

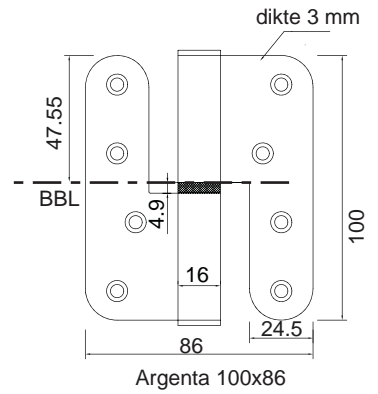

2015

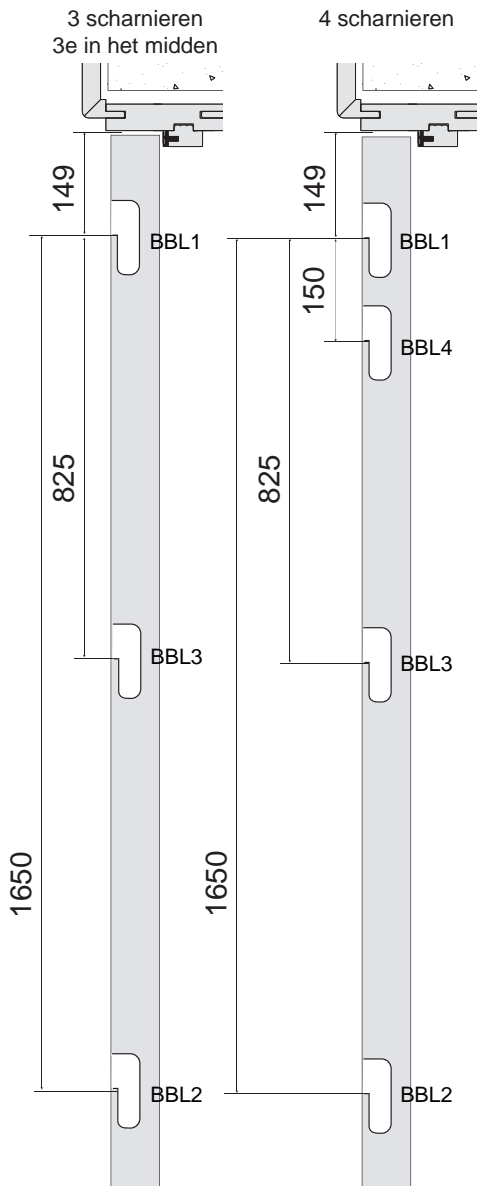

2115

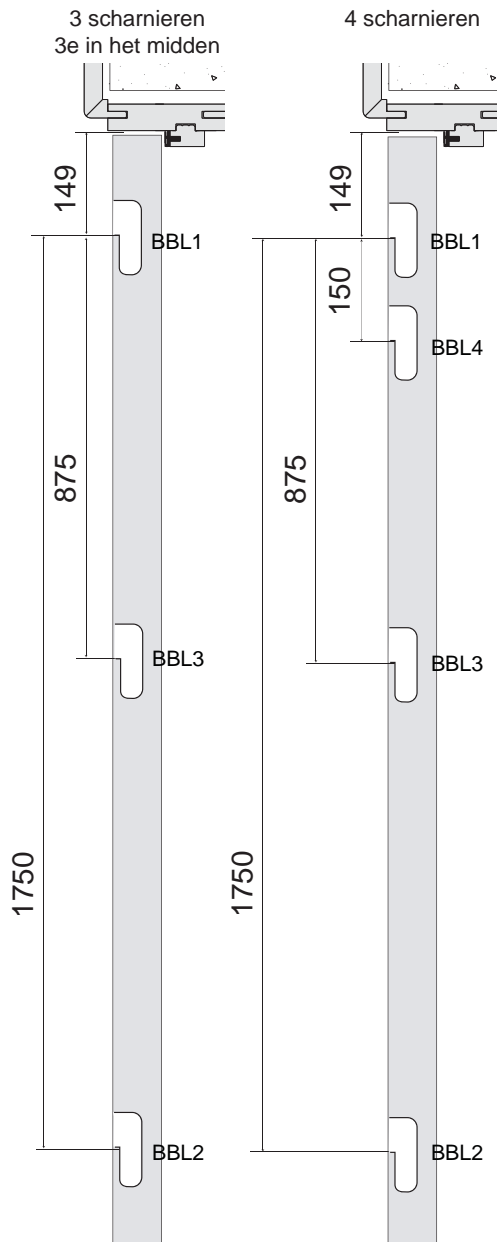

2315

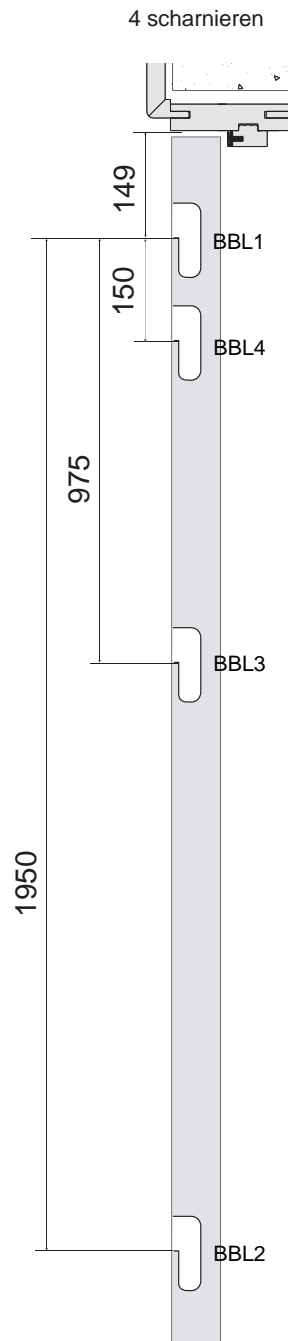

scharnier-inkrozingen bij afwijkende deurhoogtes in Fiber houten montagekozijnen

Argenta 100x86

maatvoering scharnieren-inkrozingen

3 scharnieren

deurhoogte	BBL1	BBL1-BBL2	BBL1-BBL3
1795 t/m 1894	149	1450	725
1895 t/m 1994	149	1550	775
1995 t/m 2094	149	1650	825
2095 t/m 2194	149	1750	875
2195 t/m 2294	149	1850	925
2295 t/m 2394	149	1950	975
2395 t/m 2494	149	2050	1025

maatvoering scharnieren-inkrozingen

4 scharnieren

deurhoogte	BBL1	BBL1-BBL2	BBL1-BBL3	BBL1-BBL4
1795 t/m 1894	149	1450	725	150
1895 t/m 1994	149	1550	775	150
1995 t/m 2094	149	1650	825	150
2095 t/m 2194	149	1750	875	150
2195 t/m 2294	149	1850	925	150
2295 t/m 2394	149	1950	975	150
2395 t/m 2494	149	2050	1025	150

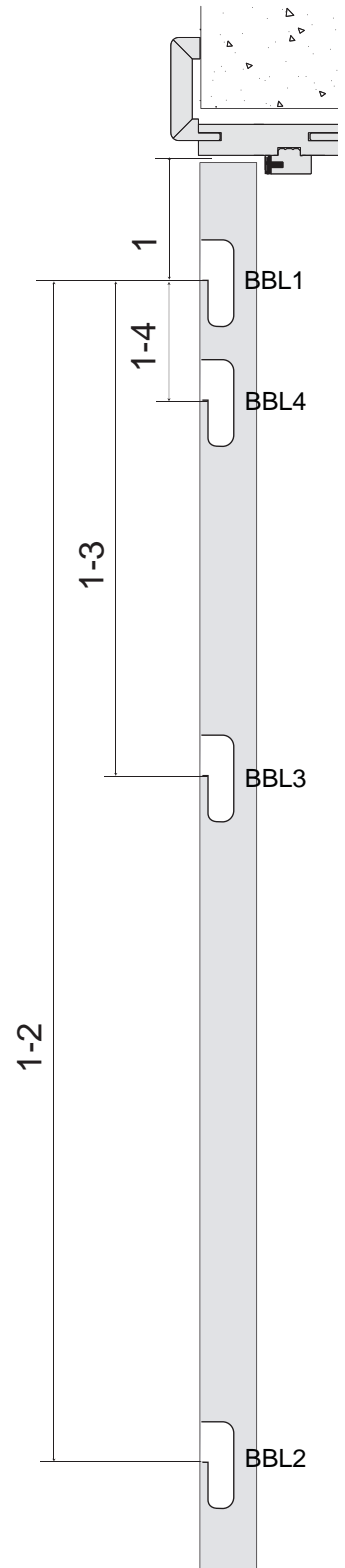

scharnier-inkrozingen bij standaard deurhoogtes in Fiber houten montagekozijnen Argenta 80x80

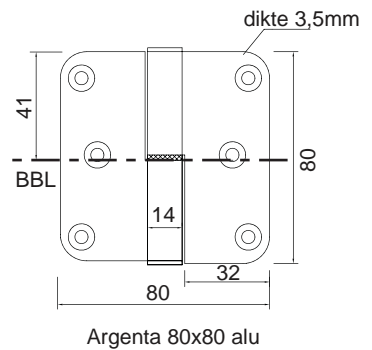

2015

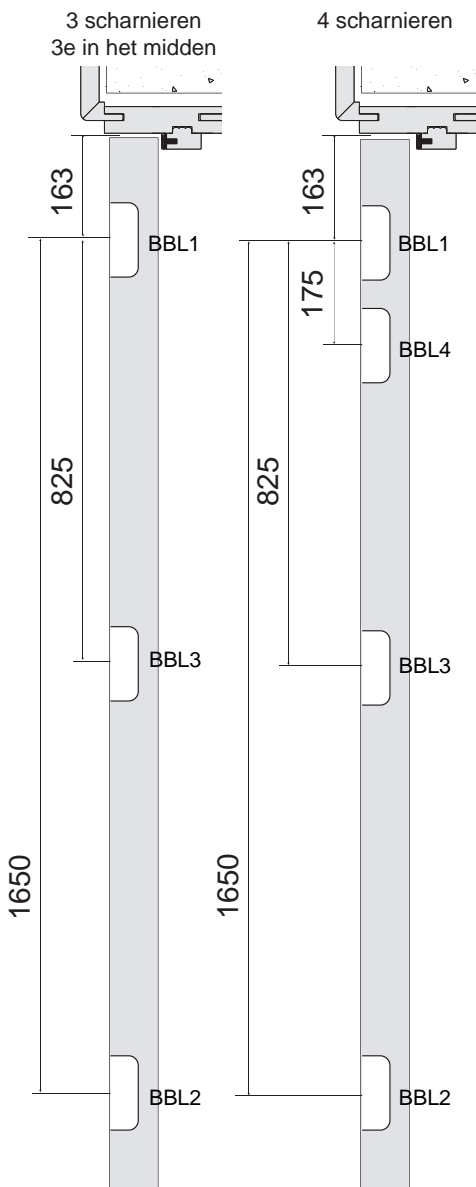

2115

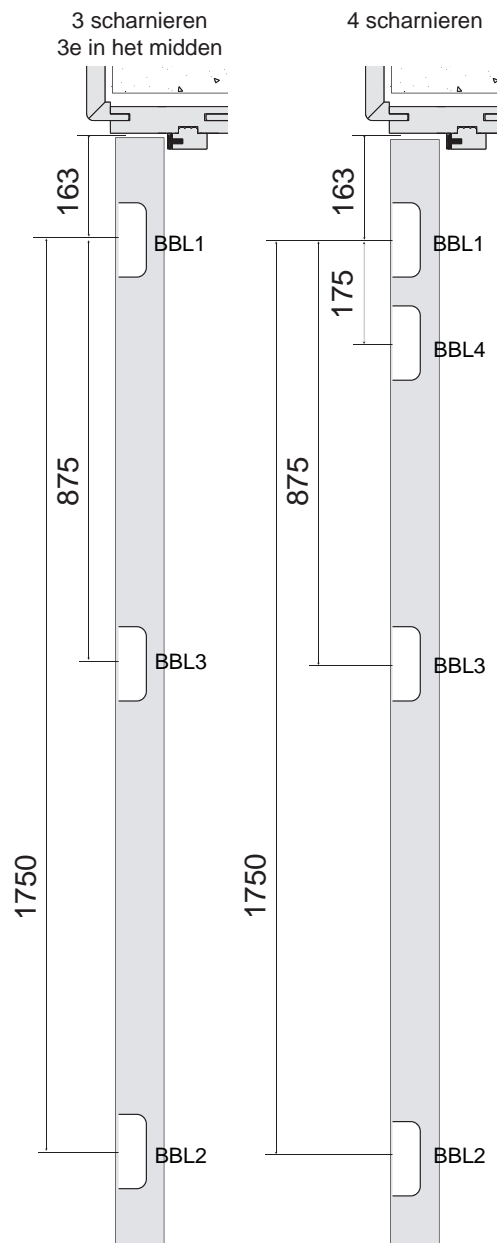

2315

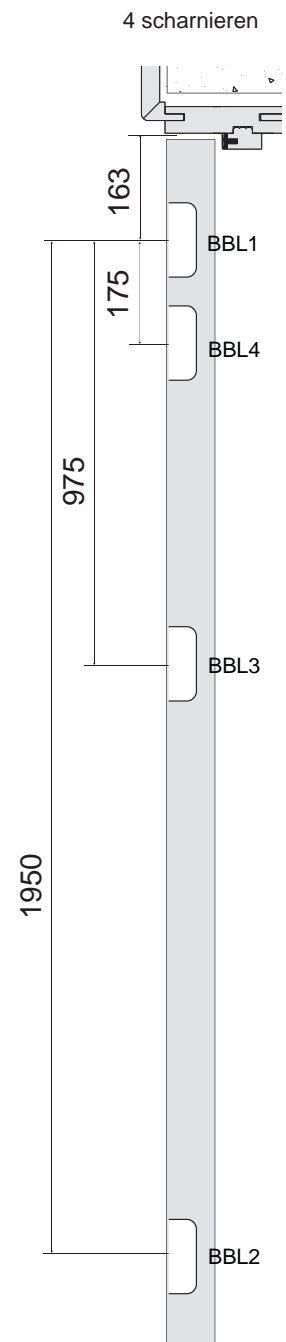

scharnier-inkrozingen bij afwijkende deurhoogtes in Fiber houten montagekozijnen Argenta 80x80

maatvoering scharnier-inkrozingen

3 scharnieren

deurhoogte	BBL1	BBL1-BBL2	BBL1-BBL3
1795 t/m 1894	163	1450	725
1895 t/m 1994	163	1550	775
1995 t/m 2094	163	1650	825
2095 t/m 2194	163	1750	875
2195 t/m 2294	163	1850	925
2295 t/m 2394	163	1950	975
2395 t/m 2494	163	2050	1025

maatvoering scharnier-inkrozingen

4 scharnieren

deurhoogte	BBL1	BBL1-BBL2	BBL1-BBL3	BBL1-BBL4
1795 t/m 1894	163	1450	725	175
1895 t/m 1994	163	1550	775	175
1995 t/m 2094	163	1650	825	175
2095 t/m 2194	163	1750	875	175
2195 t/m 2294	163	1850	925	175
2295 t/m 2394	163	1950	975	175
2395 t/m 2494	163	2050	1025	175

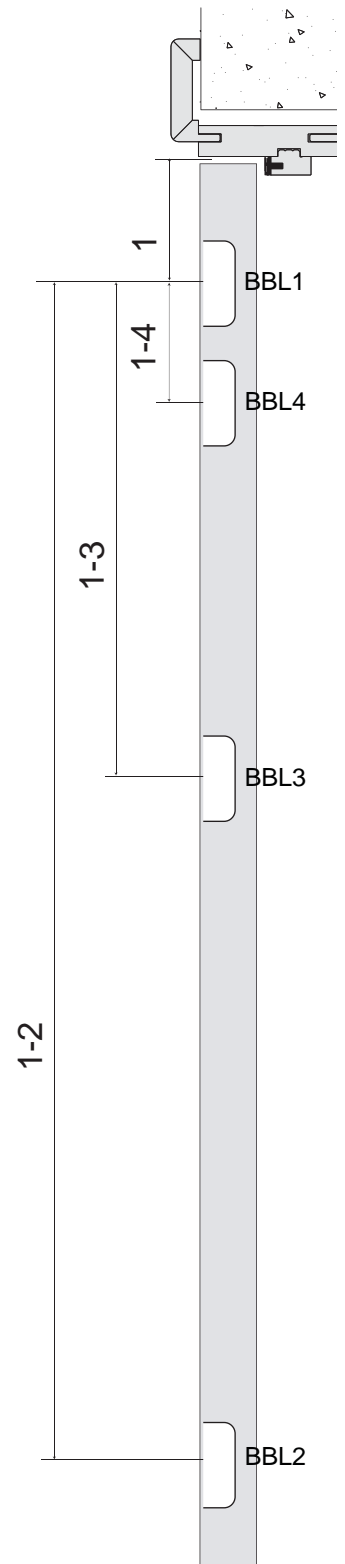



Vestiging België
Zandstraat 10 / B-3460 Bekkevoort
t. +32 (0)13 351 200 / f. +32 (0)13 312 738
www.theuma.com / info@theuma.com

Vestiging Nederland
Amersfoortseweg 9 / NL-3751 LJ Bunschoten
P.O. Box 5 / NL-3750 GA Bunschoten
t. +31 (0)88 00 27 500 / f. +31 (0)88 00 27 400
www.theuma.nl / info@theuma.nl